

Monitoring the Nailed Soil Wall at Önzberg

Surveillance d'un mur cloué à Önzberg

Arno Thut, Daniela Heitz
Solexperts AG, Schwerzenbach, Schweiz; contact@solexperts.com



Leonhard Schmid
smh Tunnelbau AG, Rapperswil, Schweiz

KEYWORDS: observational method, nailed soil, sliding deformer, inclinometer

ABSTRACT: By monitoring a nailed soil excavation wall of up to 15 m height the deformations could be checked and appropriate additional safety measures regarding the local ground conditions could be applied.

RESUME: Un mur cloué jusqu'à une hauteur de 15 m a été surveillé par des mesures de déplacement dans le massif. En raison des déplacements importants et des conditions géotechniques des travaux de confortements ont été localement entrepris.

1 INTRODUCTION

Within the framework of the project Rail 2000 a new 45 km long stretch of railway line was constructed between Mattstetten and Rothrist near Herzogenbuchsee (Figure 1). It will allow speeds of 200 km/h and shortens the travel time between Zurich and Berne by 15 minutes.

In the densely populated lowland areas of northern Switzerland there is great concern about reducing noise emissions, which after a planning time of more than 20 years resulted in one-third of the total stretch of railway line being put underground.

The Önzberg tunnel is an essential element of the branching at Wanzwil, with the new double track stretch connecting without any crossings with the single track line to Solothurn. The western third of the Önzberg tunnel was built by the cut-and-cover method, the rest with the help of a TBM.

For the cut-and-cover stretch an 8 to 14 m deep excavation around 800 m long was constructed, and with the exception of the portal region (with a pile wall system) it was supported by a nailed soil wall. The slope of the face of the wall was 5:1 on the south side and 10:1 on the north side.

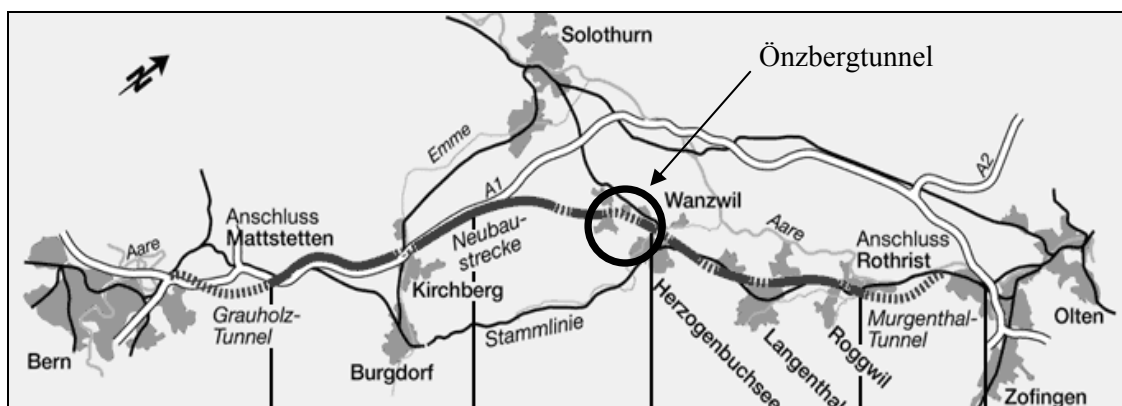

Figure 1. Overview of the new stretch of railway line between Mattstetten and Rothrist

2 GROUND CONDITIONS

From the geotechnical model (Figure 2) it is clear that an 8 to 14.0 m thick layer of moraine is above the Lower Molasse (USM) consisting of sandstone, siltstone and claystone. The deck layer consists of a 2.2 to 2.8 m thick (including humus ~ 0.3 m) weathered layer.

The weathered layer can be considered to be an in situ soil formation, consisting of lightly to strongly silty fine sand (CM, SM) with little gravel, whose in situ density varies from loose to medium dense. In the boreholes SB1 and SB2 SPT values of $N_{30} = 7$ and 27, respectively, have been measured.

The layers of moraine consist for the most part of slightly cohesive fine and medium sand with medium gravel, and in places clayey zones are encountered. The clay fraction amounts to a maximum of 15%. Gravel found in lenses has a grain size between 10 and 60 mm. Stones and blocks were only occasionally encountered in the boreholes (\varnothing up to 20 cm).

On the basis of the SPT tests the moraine exhibits very variable densities. The upper 4.0 m comprise loose soil ($N_{30} = 4$ to 9). Generally though the density increases from medium dense ($N_{30} = 16$ to 33) through dense to very dense ($N_{30} = 39$ to 182) with increasing depth. In the eastern region of the cut-and-cover stretch, however, medium dense conditions are possible down to the bedrock ($N_{30} = 14$ to 29).

In the borehole SB1 oedometer tests could be carried out on fine grained samples, the value amounting at a depth of 4.5 m to 14.4 MN/m² and at 7.2 m to 21.1 MN/m². The deformation moduli will almost certainly vary in accordance with the soil density, whereby the values obtained can be assumed to represent minimum values.

The permeability in the fine and medium grain size region amounted to 10^{-7} to 10^{-8} m/sec, and in the gravel deposits to $3 \cdot 10^{-5}$ to $3 \cdot 10^{-5}$ to 10^{-6} m/sec.

Measurements of the ground water table exhibit different pressure heads, and in the moraine it reaches to the weathered layer.

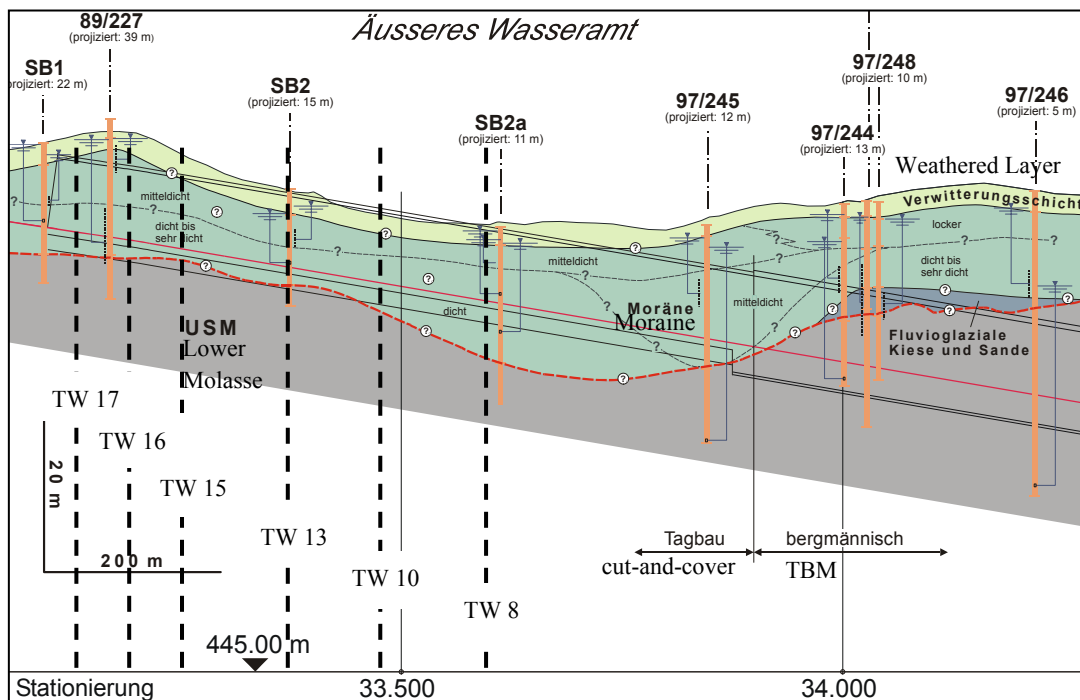

Figure 2. Geotechnical model for the cut-and-cover stretch

3 CONSTRUCTION MEASURES

Due to the ground conditions and for reasons of economy a nailed soil wall with sub-horizontal drainage boreholes was chosen.

Table 1. Nails and drainage boreholes

Nails	length 8-10 m diameter 20 mm slope 6° horizontal spacing 1.40 m vertical spacing 1.50 m maximum force 56 kN borehole diameter 114 mm
Drainage boreholes	length 12 m arrangement as with nails

At the start of work in the western part, over a length of around 40 m, large displacements were observed by geodetical means, which did not stabilise. There the bottom of the wall was strengthened by means of 40 mm GEWI anchors (micropiles) and prestressed anchors with 200 kN prestress.

4 CHECKING THE EXCAVATION SUPPORTS

With the given geotechnical construction parameters (deep excavation, embankments, piles, tunnelling, etc.) the dimensioning is based on isolated information from boreholes. Especially in strongly heterogeneous ground, as is the case in the moraine material, it is very important that predicted load bearing and deformational behaviour are checked. The geotechnical measurements are an important element for checking the safety and if necessary adapting the construction process and the constructional measures.

As mentioned above various hazard scenarios were apparent at the beginning of the work

- flaking away or slip of soil at the face of the nailed soil wall, probably due to water-bearing layers
- local instabilities at the bottom of the excavation
- potential deep sliding of the soil blocks reinforced with nails
- poor bonding in places between soil and sprayed concrete (Figure 3)



Figure 3. Slumping of the sprayed concrete

After taking into account the above mentioned hazard scenarios the originally planned measuring programme was extended (strain gauges in the nails at 1.0 m spacing, inclinometer and piezometer measurements). Six measuring cross sections distributed along the excavation (Figure 2) were instrumented as shown in Figure 4:

- at the north and south sides each has 1 sliding deformer / inclinometer measuring tube 18 to 19 m long, inclined at 15° to the vertical
- depending on the height of the wall at the south and north sides each has 1 to 2 sliding deformer / inclinometer measuring tubes, 16 to 19 m long, inclined at 6° to the horizontal downwards.
- strain measurements in the nails with the sliding micrometer

With the arrangement of these measuring lines the deformational behaviour of the support system and the adjoining soil could be recorded.

5 RESULTS OF MEASUREMENTS

The observed total displacements at the top (sub-vertical measuring lines S1, N1) of the wall and at a depth of 4.0 m (sub-horizontal measuring lines S2, N2) are listed in Table 1.

Table 2. Önzberg nailed soil wall displacements in mm

MQ	S1/h	S1/v	S2/h	S2/v	N1/h	N1/v	N2/h (N3/h)	N2/v (N3/v)
TW8	118	79	32	45	107	58	130	115
TW10	tubes drilled through could not be measured				103	73	40	58
TW13	42	21	19	35	102	73	41	40
TW15	96	55	-	20	77	39	41	40
TW16	-	-	-	-	-	-	21 (34)	16 (16)
TW17	66	44	28	55	33	23	-	-

For the measuring cross sections on the north side the measured displacement at the face of the wall at a depth of 4.0m exhibited the same order of magnitude as at the top of the wall. This showed that the main displacement occurred in the lower part of the wall. In the measuring cross sections on the south side the displacements are more uniformly distributed. The geodetical measurements on the face of the wall confirmed the displacement measurements, but are higher and reach 200 mm. The reason for this is probably the poor bond between the soil and the sprayed concrete in some places. The different behaviour of the reinforced body of soil acting as a retaining wall is due to the steepness of the wall (10:1 North 5:1 South). The displacements underneath the wall, based on the sub-vertical boreholes, are, with 1 to 2 mm, small. Exceptions can be observed with TW10 South with horizontal displacements greater than 25 mm and vertical displacements greater than 5 mm. A further exception is observed at TW18 North: Horizontal displacements of 18 mm and vertical displacements of 21mm extending well beyond the nails indicate an instability, which could be prevented by supporting the face of the wall with GEWI piles (Figure 10).

Behind the retaining wall in the region of transition Nails-Soil the horizontal displacements amount to 8 to 25 mm and vertically as settlement to 0 to 20 mm.

Figure 4 presents the differential displacement vectors meter by meter and Figure 5 presents the summation of the values. Figure 6 presents the differential displacement vectors in the measuring cross section TW6 North in the two sub-horizontal boreholes N2 and N3.

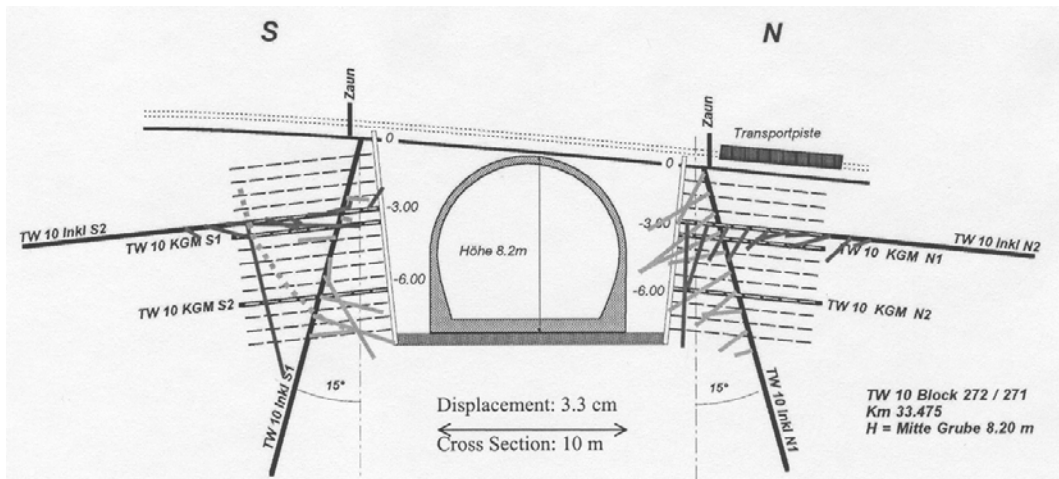

Figure 4. TW10: Differential displacements of the combined Sliding Deformeter / Inclinometer measurements.

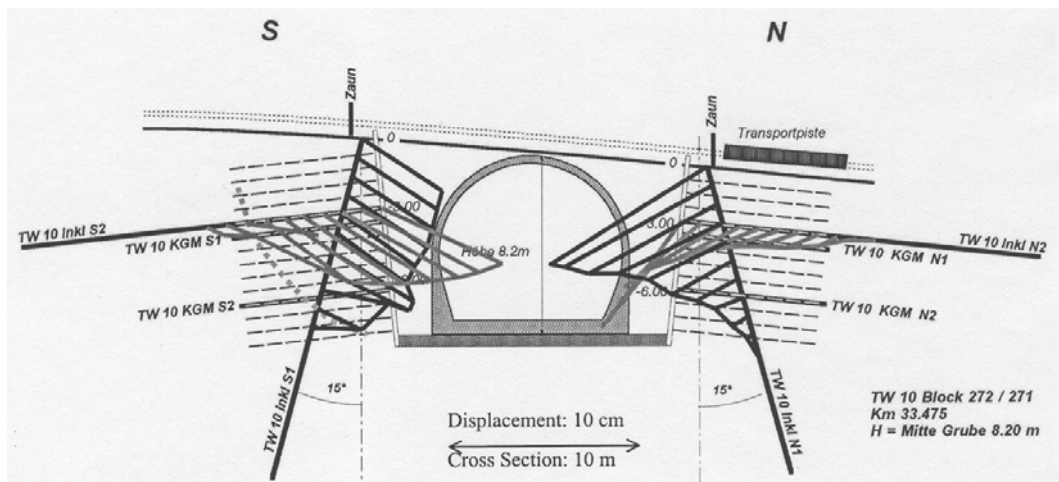

Figure 5. TW10: Integrated displacements from the combined Sliding Deformeter / Inclinometer measurements.

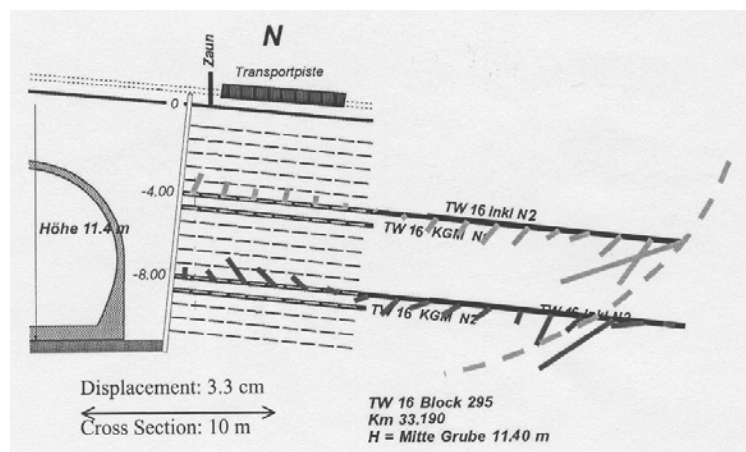

Figure 6. TW 16 Differential vertical displacements on the north side

5.1 Displacement measurements in the ground and at the heads of the nails

TW 10 South: The biggest differential displacements (Figure 4) occur in the horizontal measuring tube S2 at 6.5 m distance from the nailed soil wall and vertically (Inkl S1) about 7 m from the top of the excavation or 4.5 m from the nailed soil wall. Here a potential sliding surface is possible, and the forces in the nails KGM S1 and KGM S2 were activated.

Figure 5 presents the total summation of displacements. The graphical presentation confirms that the main displacements occur in a pronounced zone and the remainder of the mass of soil in itself is relatively stable.

TW 10 North: The measuring data for N1 and N2 show a completely different deformation picture. The differential displacement vectors for both measuring lines N1 and N2 are relatively uniformly distributed over the whole nailed area. A lean towards the excavation with maximum values up to 107 mm was measured. Towards the face of the wall the displacements increase and indicate a tendency for a slip to develop as observed in the zone at the front.

TW16 North: Based on the differential displacement vectors (Figure 6) with both sub-horizontal boreholes a potential shearing area about 10 m behind the nails must be assumed. In the region of the reinforced soil mass the vectors are directed upwards, i.e. a small rotation of the wall has occurred.

5.2 Strain measurements in the nails

The forces in the nails determined from the measurements vary on the whole between 50 and 80 kN, whereas for Nail TW10 KGM S2, (Figure 7) a value of about 200 kN was observed. This may be due to an error in measurement, since the elastic limit of 500 N/mm² would have been exceeded. Other nails, on the other hand, were not activated and did not take up any load (TW10 N2, no figure). Both measuring methods (strain gauges, Figure 7 and compact sliding micrometer, Figure 8) gave similar distributions, whereby the maximum force occurred in the region at the far end of the nail.

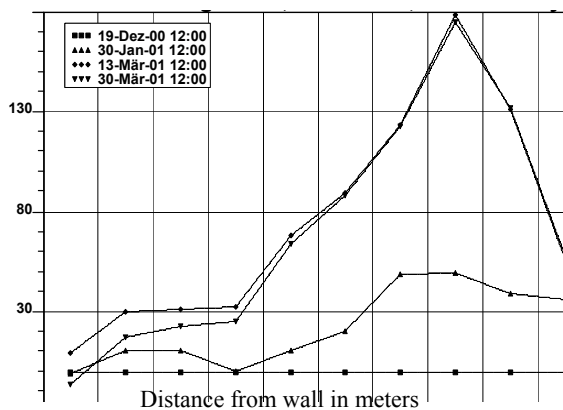

Figure 7. Stress measurements in the nails using strain gauges

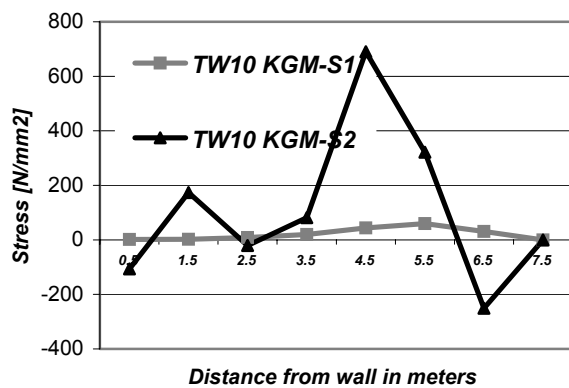

Figure 8. Strains in the nails converted to stresses with TW10 KGM S1 and S2.

The visual observations show that the nails follow the relatively large displacements, i.e. the head of the nail moved up to ~100 mm and thus the friction forces would have been fully mobilised. The summation of the observed strains with KGM S1 amounts to 3 mm, that of KGM S2 to 5 mm.

5.3 Pull-out tests

Pull-out tests were carried out on several nails. The initial force amounted to 14 kN, and then the nails were loaded up to 56 kN, 98 kN and 140 kN and the displacements were measured for each load step over a period of 15 to 30 minutes. Some exhibited creep in the higher load steps.

Table 3. Pull-out tests: Force – Initial Force = 126 kN

Nail No.	Position from top of excavation [m]	Nail length [m]	Permanent deformation [mm]	Elastic deformation [mm]
1	-3.40	10	2.31	6.68
7	-3.40	6	8.68	5.02
35N	-3.00	10	13.10	9.18

6 INTERPRETATION AND CONSTRUCTIONAL MEASURES

The forces in the nails can only be built up when the soil deforms, since the nails are not prestressed. The displacements measured at the heads of the nails were sometimes twice as large as those resulting from the modelling of about 4.5 cm.

Based on the measured strains in the nails and the displacement measurements in the ground, which do not indicate the development of any shear surface behind the nails (except TW 16), it can be assumed that the pull-out resistance of the nails and also the length of nail were sufficient.

The large displacements in the reinforced body of soil are due to the geotechnical parameters, with in places small in situ densities and also in part to high compressibility as well as to the steep slope of the wall (it leads to high normal forces).

On the north side the settlement of the excavation wall was caused by the steep slope of the wall and partly by the self-weight of the sprayed concrete lining or a lack of bond between the sprayed concrete and the soil. In the bottom stages of excavation the already concreted upper section tended to settle in places.

Finally, the behaviour of the nailed soil wall could be improved and a potential slip in critical areas could be prevented by supporting the self-weight on micropiles for the bottom stages of excavation (Figure 9 and 10).



Figure 9. Installation of the micropiles

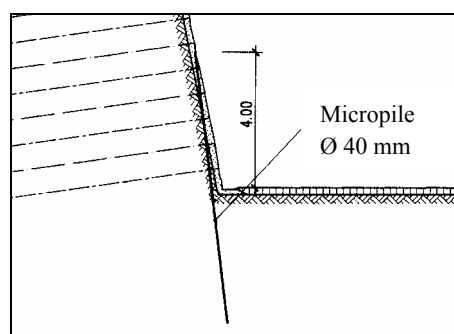

Figure 10. Arrangement of the micropiles

REFERENCES

- <http://www.sbb.ch/bahn2000/> Schweizerische Bundesbahnen SBB
<http://www.mbn.ch/oenzberg.htm> Matousek, Baumann & Niggli AG:
 Ingenieurgesellschaft AQUIPA. Nagelwand west. Statische Berechnungen
 Ingenieurgesellschaft AQUIPA. Lenkungsplan